

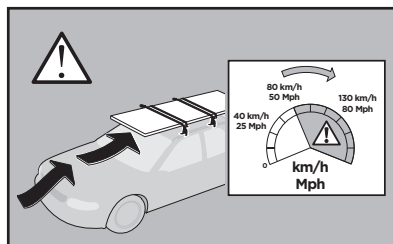

## Thule Rapid System Kit 1815

# > Instructions

MINI Clubman, 5-dr Hatchback, 16-

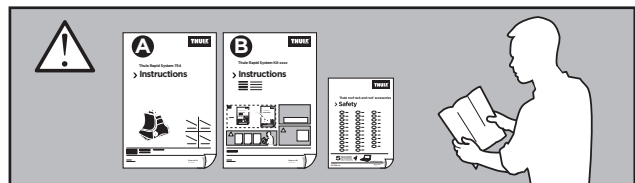
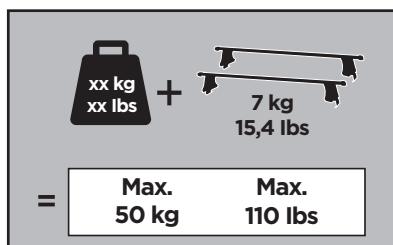

ISO 11154-E

141815  
C.20151211  
519-1815-01

Bring your life  
thule.com



182 x4

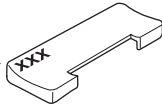

1372 x4



52576

x2



x1



x1

1

	X (scale)	X (mm)	X (inch)
MINI Clubman, 5-dr Hatchback, 16-	31.5	966	30 1/2

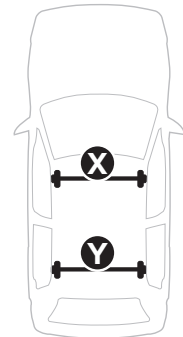
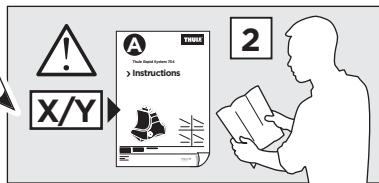
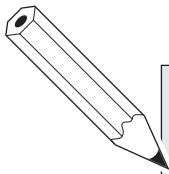

	Y (scale)	Y (mm)	Y (inch)
MINI Clubman, 5-dr Hatchback, 16-	30.5	956	37 5/8

2

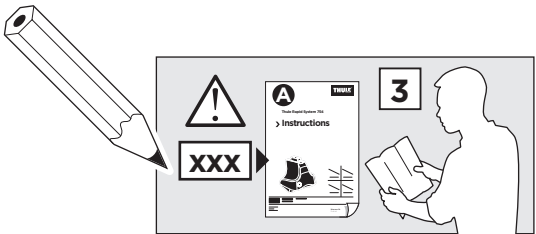
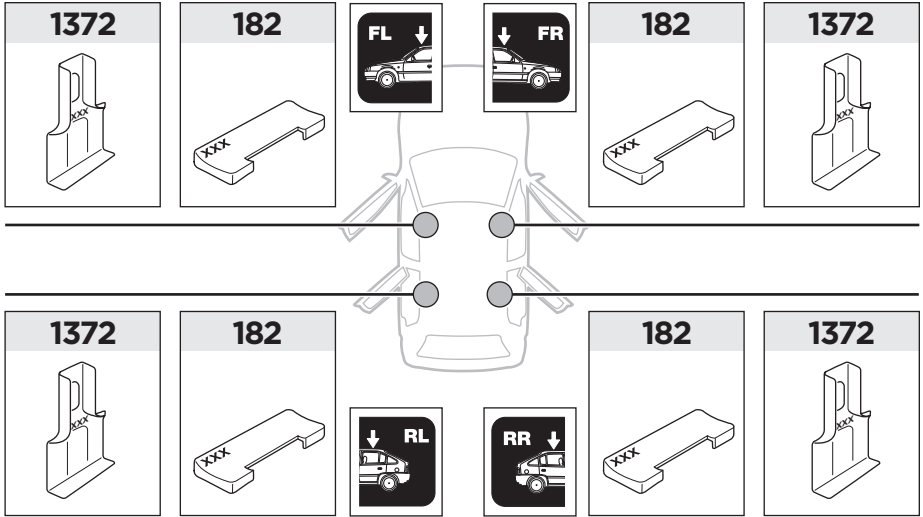

3

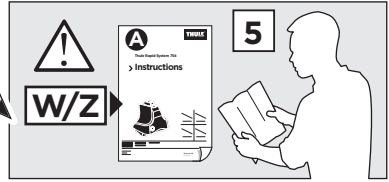

	W (mm)	Z (mm)	W (inch)	Z (inch)
<b>MINI Clubman</b> , 5-dr Hatchback, 16-	<b>385</b>	<b>745</b>	<b>15 1/8</b>	<b>29 3/8</b>

